

1-190-S Standard trigger hooks (set)



DESCRIPTION

The set of three standard pulling hooks is suitable for 3-arm universal pullers. The robust pulling hooks guarantee particularly safe removal of bearings, gears and discs.

RANGE OF APPLICATION

As a spare part for the particularly safe removal of bearings, gears and discs.

BENEFIT

- Eccentric components can also be pulled off thanks to the free-moving Pulling hooks that slide on the Crossbeam

MASTER DATA

GTIN [EAN]	4021176001741
Country of origin	DE
Case material	Tool steel
Series	0-S
Net weight [kg]	1,685 kg
Package contents	1 set
Packaging Act	PAP 21
Global sales capability given	Yes

Standard trigger hooks (set)

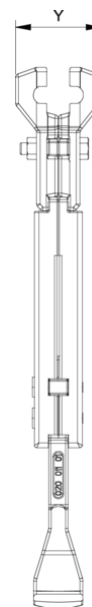
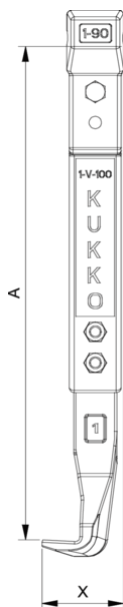

Abbreviation	Attribut	Wert
A	Clamping depth outside pull-off [mm]	200 mm
K	Hook root thickness at the tip (claw thickness K) [mm]	3 mm
J	Hook base width (claw width J) [mm]	20 mm
O	Hook base depth usable (claw depth usable O) [mm]	15 mm
H	Total hook root depth (total claw depth H) [mm]	31 mm
L	Total claw thickness (L+1mm) (claw distance to base surface) [mm]	10 mm
Z	Total length [mm]	232 mm

Abbreviation	Attribut	Wert
A	Clamping depth outside pull-off [mm]	200 mm
K	Hook root thickness at the tip (claw thickness K) [mm]	3 mm
J	Hook base width (claw width J) [mm]	20 mm
O	Hook base depth usable (claw depth usable O) [mm]	15 mm
H	Total hook root depth (total claw depth H) [mm]	31 mm
L	Total claw thickness (L+1mm) (claw distance to base surface) [mm]	10 mm
Z	Total length [mm]	232 mm

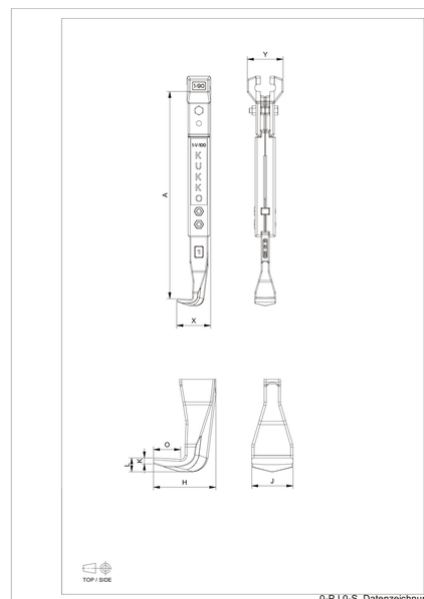
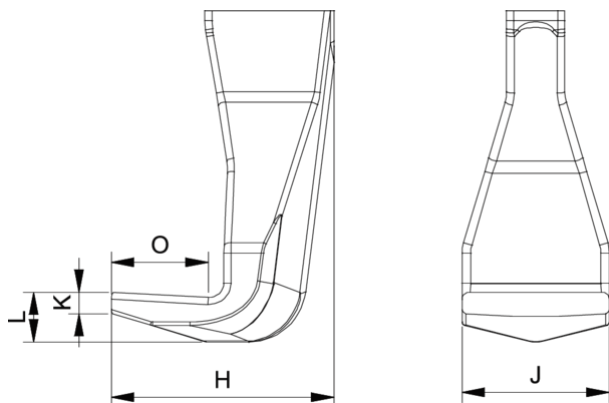

Abbreviation	Attribut	Wert
A	Clamping depth outside pull-off [mm]	200 mm
K	Hook root thickness at the tip (claw thickness K) [mm]	3 mm
J	Hook base width (claw width J) [mm]	20 mm
O	Hook base depth usable (claw depth usable O) [mm]	15 mm
H	Total hook root depth (total claw depth H) [mm]	31 mm
L	Total claw thickness (L+1mm) (claw distance to base surface) [mm]	10 mm
Z	Total length [mm]	232 mm

Abbreviation	Attribut	Wert
A	Clamping depth outside pull-off [mm]	200 mm
K	Hook root thickness at the tip (claw thickness K) [mm]	3 mm

J	Hook base width (claw width J) [mm]	20 mm
O	Hook base depth usable (claw depth usable O) [mm]	15 mm
H	Total hook root depth (total claw depth H) [mm]	31 mm
L	Total claw thickness (L+1mm) (claw distance to base surface) [mm]	10 mm
Z	Total length [mm]	232 mm