

## 2-300-S Standard trigger hooks (set)



### DESCRIPTION

The set of three standard pulling hooks is suitable for 3-arm universal pullers. The robust pulling hooks guarantee particularly safe removal of bearings, gears and discs.

### RANGE OF APPLICATION

As a spare part for the particularly safe removal of bearings, gears and discs.

### BENEFIT

- Eccentric components can also be pulled off thanks to the free-moving Pulling hooks that slide on the Crossbeam

### MASTER DATA

GTIN [EAN]	4021176002816
Country of origin	DE
Case material	Tool steel
Series	0-S
Net weight [kg]	3,78 kg
Package contents	1 set
Packaging Act	PAP 21
Global sales capability given	Yes

# Standard trigger hooks (set)

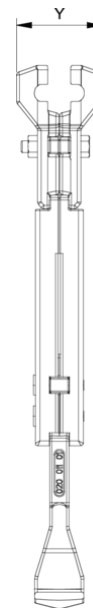
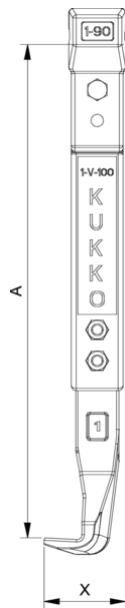

Abbreviation	Attribut	Wert
A	Clamping depth outside pull-off [mm]	300 mm
K	Hook root thickness at the tip (claw thickness K) [mm]	4 mm
J	Hook base width (claw width J) [mm]	24 mm
O	Hook base depth usable (claw depth usable O) [mm]	18 mm
H	Total hook root depth (total claw depth H) [mm]	40 mm
L	Total claw thickness (L+1mm) (claw distance to base surface) [mm]	9 mm
Z	Total length [mm]	343 mm

Abbreviation	Attribut	Wert
A	Clamping depth outside pull-off [mm]	300 mm
K	Hook root thickness at the tip (claw thickness K) [mm]	4 mm
J	Hook base width (claw width J) [mm]	24 mm
O	Hook base depth usable (claw depth usable O) [mm]	18 mm
H	Total hook root depth (total claw depth H) [mm]	40 mm
L	Total claw thickness (L+1mm) (claw distance to base surface) [mm]	9 mm
Z	Total length [mm]	343 mm

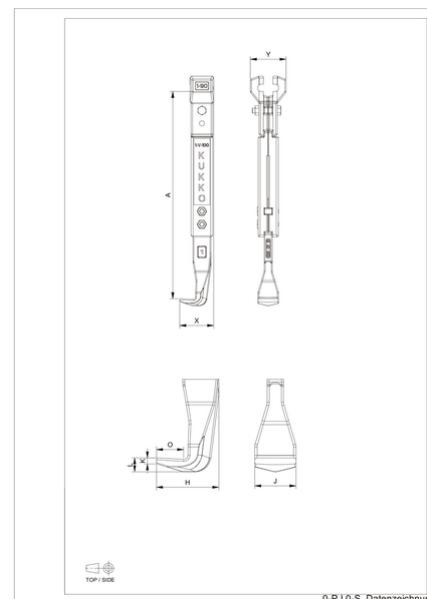
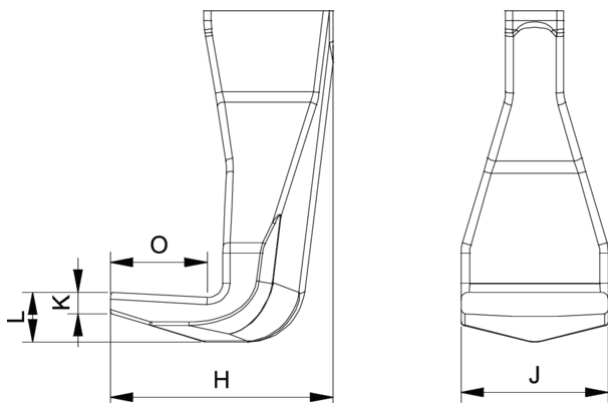

Abbreviation	Attribut	Wert
A	Clamping depth outside pull-off [mm]	300 mm
K	Hook root thickness at the tip (claw thickness K) [mm]	4 mm
J	Hook base width (claw width J) [mm]	24 mm
O	Hook base depth usable (claw depth usable O) [mm]	18 mm
H	Total hook root depth (total claw depth H) [mm]	40 mm
L	Total claw thickness (L+1mm) (claw distance to base surface) [mm]	9 mm
Z	Total length [mm]	343 mm

Abbreviation	Attribut	Wert
A	Clamping depth outside pull-off [mm]	300 mm
K	Hook root thickness at the tip (claw thickness K) [mm]	4 mm

J	Hook base width (claw width J) [mm]	24 mm
O	Hook base depth usable (claw depth usable O) [mm]	18 mm
H	Total hook root depth (total claw depth H) [mm]	40 mm
L	Total claw thickness (L+1mm) (claw distance to base surface) [mm]	9 mm
Z	Total length [mm]	343 mm